

Article number: 021816011080

Description: Clamp with bracket and rubber
SPGU 6011. 80/30 SK

Measures

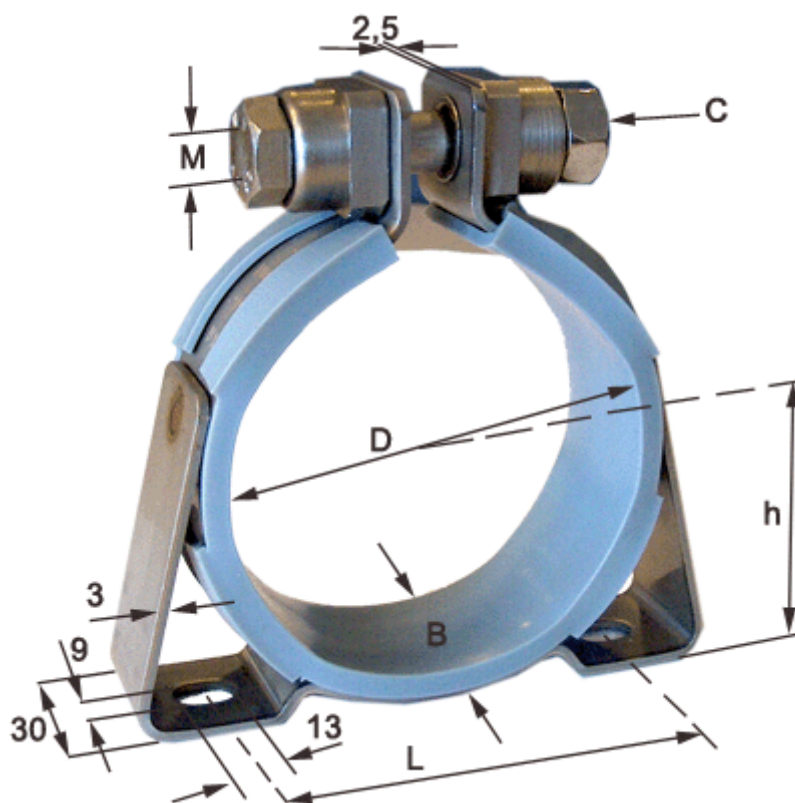

C (screw type) = SK hexagon screw

Diameter D = 80

h = 48

L = 82

Width B = 30